

Explosion-Protected Light Fitting with Tapered Sheet Steel Body for Zones 2 and 22 Series nD181/182...



Applications:

Areas with explosive atmospheres of Zones 2, 22, preferably in paint shops, paint-spray lines and spray booths.

Design:

Housing: Sheet steel, powder coated in white (RAL 9016), stainless steel upon request.

Glass cover: Impact resistant safety glass pane, frameless / hinged.

Reflector: Hinged, white painted sheet steel, detachable.

Central locking system operated by a 5mm allen key, inner hinges on the opposite side.

Wiring: Eletronic ballast.

Connection terminals: Standard: L1 + N + PE up to 2,5mm².

Cable entries: 3 entries M25 x 1,5 (2 glands, 1 of them with plug and 1 screw plug) LOOP-IN/OUT possible, for some versions temperature resistant cable is required

Through wiring system: 5 x 2,5mm² through wiring or preparation for 5-pole LOOP-IN/OUT at extra charge

Standard: Facing downwards or forwards

Mounting: Suspension hooks (**H8V P**) or ceiling brackets (**15A P**), at extra charge (see accessories)

Note:

For installation in humid and corrosive atmospheres please select light fittings with housings in stainless steel.

When switched off the light fittings must not be exposed to an a.t. of more than +85°C

NEW

DB standardized by Deutsche Bahn AG

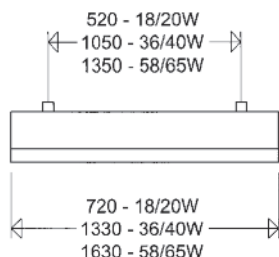

Suspension hooks H8V

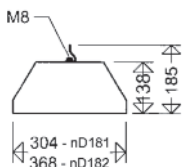

Ceiling brackets 15A

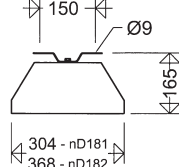

T 26

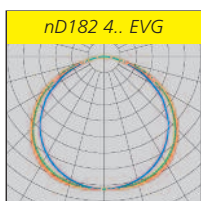

SCHUCH Quality - your advantage:

- sturdy design of high chemical resistance for application in rough industrial conditions:
 - housing made from powder coated sheet steel or upon request from stainless steel
 - frameless safety glass pane
 - solid central locking system made from galvanized steel and high-grade aluminium hinges
- easy to install and maintain, safety implemented
 - Original SCHUCH central locking system with hingeable safety glass pane for easy lamp replacement
 - easily accessible connection compartment via hingeable reflector
- wide range of application and flexibility at most different environmental conditions
 - for gas and dust hazardous areas (Zones 2 and 22)
 - wide range of Permissible ambient temperatures -20°C up to +40/50°C
 - separate frame for recessed installation and a swivel arm mounting system can be installed at a later stage. A high flexibility of application combined with economic storing is guaranteed
 - looping system on one side of the housing; bilateral through wiring system (on request)

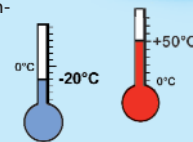

nD181/182...



II 3 G Ex nA IIC T4

II 3 D Ex tD A22 T80°C

IP65



Other approvals:

GOST-R/ROSTECH-NADZOR (Russia)

Ignition protection: nA

Marking:

II 3 G Ex nA IIC T4 (Zone 2)

II 3 D Ex tD A22 IP65 T80°C (Zone 22)

Permissible ambient temperature:

-20°C to +40/50°C (1 or 2 lamps)

-20°C to +40°C (3 or 4 lamps)

Rated voltage: 220-240 V AC/DC, 0 or 50/60 Hz.

Type	Article no.	Temp. class	Lamps W	Weight ca. kg
narrow housing				
nD181 118 EVG	18001 0001	T4	1 x T 26/18W	9,6
nD181 218 EVG	18001 0002	T4	2 x T 26/18W	10,1
nD181 318 EVG	18001 0007	T4	3 x T 26/18W	10,7
nD181 136 EVG	18001 0003	T4	1 x T 26/36W	17,3
nD181 236 EVG	18001 0004	T4	2 x T 26/36W	17,3
nD181 336 EVG	18001 0008	T4	3 x T 26/36W	16,9
nD181 158 EVG	18001 0005	T4	1 x T 26/58W	20,1
nD181 258 EVG	18001 0006	T4	2 x T 26/58W	20,1
nD181 358 EVG	18001 0009	T4	3 x T 26/58W	21,6
wide housing				
nD182 318 EVG	18001 0201	T4	3 x T 26/18W	10,0
nD182 418 EVG	18001 0202	T4	4 x T 26/18W	14,0
nD182 336 EVG	18001 0203	T4	3 x T 26/36W	16,8
nD182 436 EVG	18001 0204	T4	4 x T 26/36W	16,8
nD182 358 EVG	18001 0205	T4	3 x T 26/58W	27,0
nD182 458 EVG	18001 0206	T4	4 x T 26/58W	27,0

Looping the cable on one side:

All light fittings of series e187/188.. have got 2 cable entries on one small side of the housing for cable looping instead of the through wiring system.

Dimensions of recessed installation

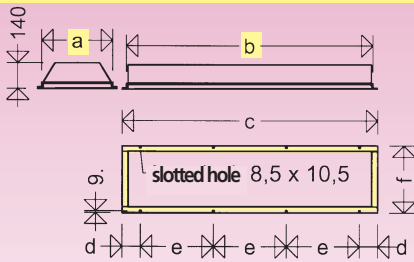

	a	b	c	d	e	f
EB 181/18	324	740	786	93	300	370
EB 181/36	324	1350	1396	98	400	370
EB 181/58	324	1650	1696	48	400	370
EB 182/18	388	740	786	93	300	434
EB 182/36	388	1350	1396	98	400	434
EB 182/58	388	1650	1696	48	400	434

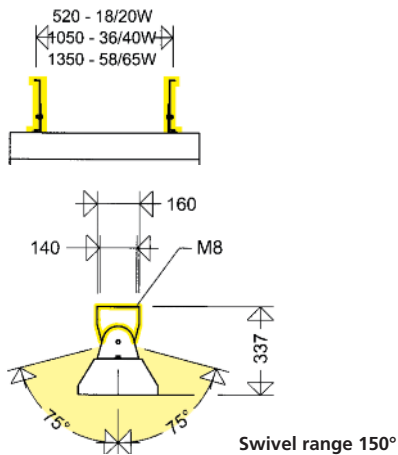

Swivel range 150°

Frame for Recessed Installation

retrofit possible!

Light fittings of series nD181/182.. can be equipped with a frame even at a later stage.

Mounting by means of M5 bolts to the long sides of the housing (see drawing).

Type	Article no.	
EB 181/18	18091 0001	frame for narrow housing, 1, 2 and 3 x 18 W
EB 181/36	18091 0002	frame for narrow housing, 1, 2 and 3 x 36 W
EB 181/58	18091 0003	frame for narrow housing, 1, 2 and 3 x 58 W
EB 182/18	18091 0004	frame for wide housing, 3 and 4 x 18 W
EB 182/36	18091 0005	frame for wide housing, 3 and 4 x 36 W
EB 182/58	18091 0006	frame for wide housing, 3 and 4 x 58 W

Swivel Arm Mounting System

retrofit possible!

Light fittings of series nD181/182.. can be equipped with a swivel arm mounting system at any time.

The swivel arms are fixed to the suspension points at the upper side of the housing. Swivel range: $\pm 75^\circ$ (see dimensions in diagram).

Type	Article no.	
SWA 181 / 182	18092 0001	for all wattages consisting of: 2 swivel arms with bolts M8



Explosion-proof Light Fittings Zone 2/22

Further Series / Equipment

- up to 4 cable entries
- different cable glands
- through wiring system up to 6 x 6.0mm²
- connecting terminal up to 6.0mm²
- with 2 individual electronic ballasts and monitoring module for individual monitoring the light fitting connected to central or group battery systems
- with isolating switch
- stainless steel housing, powder coated
- silicone free version
- zone 1-version (series e181/182...)
- non explosion-protected versions (series 181/182...) as dust- and waterproof version
- for high ambient temperatures please contact us

Mounting material

Suspension hooks H8V P

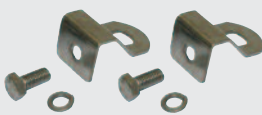

Ceiling brackets 15A P



Further accessories as well as carrier rail systems and through wiring system are available.

Accessories / Spare Parts

Type	Article no.	
Spare glasses panes		
18118-1	18090 9001	for narrow housings, 1, 2 und 3 x 18W
18136-1	18090 9002	for narrow housings, 1, 2 und 3 x 36W
18158-1	18090 9003	for narrow housings, 1, 2 und 3 x 58W
18218-1	18090 9004	for wide housings, 3 und 4 x 18W
18236-1	18090 9005	for wide housings, 3 und 4 x 36W
18258-1	18090 9006	for wide housings, 3 und 4 x 58W
Cable entries		
2537	90117 9000	explosion-protected cable gland M25 x 1,5
2539	90119 9000	explosion-protected cable gland with plug (M25 x 1,5)
2538	90118 9000	explosion-protected plug M25 x 1,5
Mounting material		
H8V P	90001 0002	2 suspension hooks with bold M8, stainless steel
15A P	90000 0002	2 ceiling brackets, steel hot galvanized
15AV P	90032 0002	2 ceiling brackets, stainless steel
WD 45 P	26000 0005	2 wall / ceiling angles 45°, steel
Lamp holder		
182/1 T140	90056 9005	ex-proof snap-type/plug-socket holder